

PHILIPS

sense **and** simplicity

Street Light Luminaire - **SMARTWAY PLUS**

N Prashantha Karanth
Outdoor Lighting
10.06.2009

PHILIPS

Smartway Plus ...



Aesthetically designed

road lighting luminaire

that meets

standard road lighting specifications

PHILIPS

Applications



- City streets
- Industrial areas
- Junction and roundabouts



PHILIPS





Smartway Plus - SPP335 - Street Light Luminaire

SALIENT FEATURES

1. Suitable for 150W SON-T/CDM-TT & 250W SON-T/CDM-TT/HPI-T
2. Single piece High pressure die cast aluminium canopy for sturdiness.
3. The canopy has ribs for additional structural strength and impact resistance.
4. Strong folded arm for safe locking in open condition during maintenance.
5. Ingress protection of IP 66 for lamp compartment
6. “Twist and Release” lamp replacement & removable gear tray for easy maintenance
7. High efficiency, high purity reflector for wide distribution
8. The front glass bowl is of toughened glass.

PHILIPS

Features & benefits

Specification	Feature	Customer Benefit
Long lasting		
- Choice of SON-T/CDM-TT 150/250W & HPIT 250W	 Multiple lamp types & wattages	Wide choice to suit most road applications
High pressure die cast housing	 Long lasting & robust	Many years of service life
Ribbed construction	 Structural design strength	Sturdy & efficient construction with good impact resistance
Stainless steel clip	 High quality material for outdoor use	Prevention against rust and corrosion
Galvanized steel double fold open arm with locking	 Strong and safe	Durable, Secure for repeated use and stress free maintenance

Specification

Feature

Customer Benefit

Sustainable and reliable

Silicon gasket installation



High quality gasket for IP66 (lamp compartment) ingress protection

Highly reliable IP 66 performance in harsh outdoor environment over time

Tempered curved glass



IK 05 impact resistance

Safe, impact resistant glass

Chain hole



To keep the luminaire safe on the pole

No potential safety issue to the road users

Breathing filter & heat sink



Good heat dissipation & air circulation

Reliable heat management to improve component life time

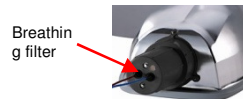

Specification

Feature

Customer Benefit

Performance with Ease

99.9% pure aluminium reflector



Increase pole spacing
good uniformity

Good road lighting performance

Two piece nylon lamp tube assembly with 30% reinforced fibre



'Twist and Release'
lamp replacement

Tool less and quick lamp replacement

Multilevel, 1.5 mm galvanized steel geartray



Strong gear tray with
key in slots &
rounded corners

Efficient & Safe maintenance

Smartway Plus – SPP335 – Street Light Luminaire

Specification for Tender

Street light luminaire with **single piece canopy** made of high pressure die cast Al and having ribs for additional structural strength and impact resistance. The luminaire shall have **glass bowl** toughened for better thermal and vandal resistance. The luminaire shall be **single toggle top opening** with twist and release lamp mechanism and removable gear tray for easy maintenance. The luminaire canopy shall have **strong folded arm for safe locking** in open condition during maintenance. The lamp compartment shall have an ingress protection of IP66. The reflector shall be electrochemically brightened anodized for high efficiency and better distribution.

PHILIPS

Choice sheet

Sr No	Type	Ordering Data 12NC	Ordering Data 9NC	Quantity per box	Dimension in mm	Net weight (kg)	Gross Weight(kg)	Volume (m3)
1	SPP335 1XSON-T 150W GB	9191 158 10064	1350 3108 5	1	710x330x240	4.5	5.6	0.0562
2	SPP335 1XSON-T 250W GB	9191 158 10065	1350 3109 5	1	710x330x240	4.5	5.6	0.0562
3	SPP335 1XHPI-T 250W GB	9191 158 10066	1350 3110 5	1	710x330x240	4.5	5.6	0.0562

PHILIPS

Product Dimensions

Dimensions

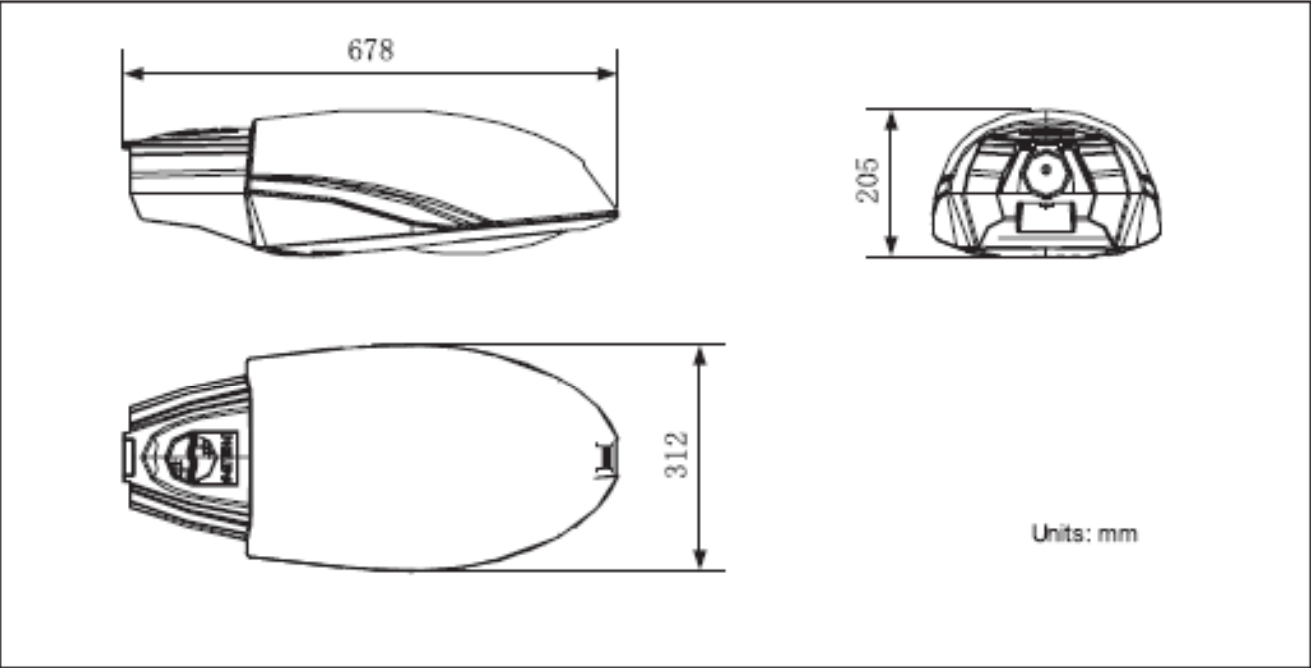

PHILIPS

Installation

Installation

